

SA

2/2-way solenoid valve of forged brass body for high temperature application

Direct-operated Type

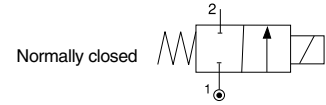

Model	Port size	Orifice (mm)	CV value	Fluid temp. (°C)	Seat disc	Differential pressure kg/cm ² (bar)				Wt. (kg)
						Liquid	Air	Steam	Oil (200°C)	
SA - 6A	1/8 "	3	0.26	-10	PTFE	0-10	0-10	0-10	0-7	0.49
SA - 6B	1/8 "	4	0.58			0-7	0-7	0-7	0-5	0.49
SA - 6C	1/8 "	5	0.64			0-5	0-5	0-5	0-3	0.49
SA - 8A	1/4 "	3	0.26	∫		0-10	0-10	0-10	0-7	0.47
SA - 8B	1/4 "	4	0.58			0-7	0-7	0-7	0-5	0.47
SA - 8C	1/4 "	5	0.64			0-5	0-5	0-5	0-3	0.47
SA - 10A	3/8 "	4	0.58	180 (200)		0-10	0-10	0-10	0-7	0.73

How to order

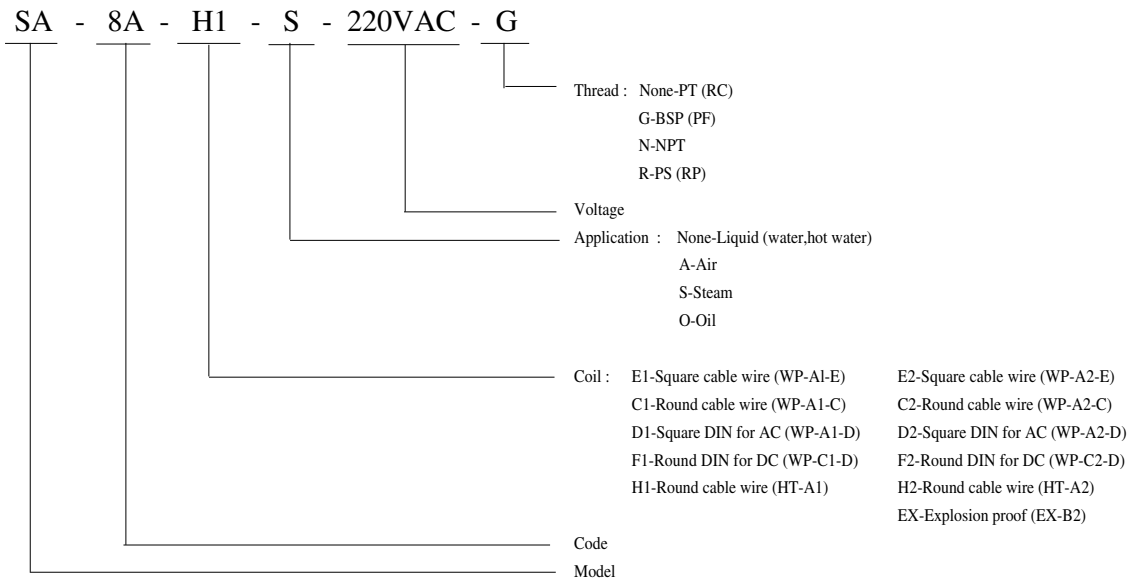

Notes:

1. Direct-acting valves are ideally suited to allocate at any angle.
2. Voltage drop range is within ±10%.
3. Pressure of voltage DC is 70% of voltage AC only.
4. Max. temperature is up to 200°C.
5. Selection of coil refer to page 136~139.
6. Oil is custom-made.
7. Standard coil is HT-A1 or HT-A2 (180°C).

Inapplicable Fluids:

1. Fluids that have kinematic viscosity over 50 CST.
2. Fluids that will turn to liquid after being heated and become solid after being cooled.
3. Corrosive fluids.

SA

2/2-way solenoid valve of forged brass body for high temperature application

● SA-6A~10A Contour Specification Chart

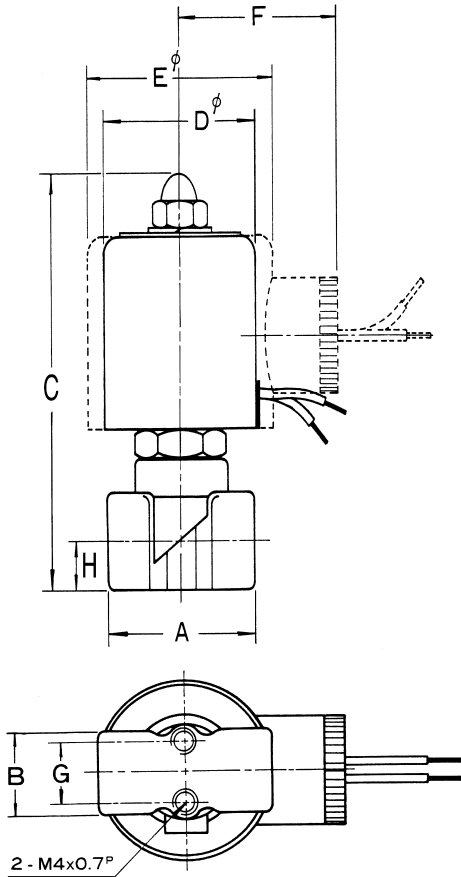

● Specifications

Unit:mm

Item Model	A	B	C	D	E	F	G	H	Coil Model
SA-6A~8C	41	19	89	41.5	--	22	15	10.5	HT-A1
	41	19	85	53	--	63	15	10.5	WP-A1-D*
	41	19	85	58	--	38	15	10.5	WP-A1-E
	41	19	86	56	--	64	15	10.5	WP-C1-D*
SA-10A	50	25	93	--	53	47	15	11.7	HT-A2
	50	25	90	--	58	65	15	11.7	WP-A2-D*
	50	25	90	--	63	40	15	11.7	WP-A2-E
	50	25	90	--	68	70	15	11.7	WP-C2-D*

* with connector

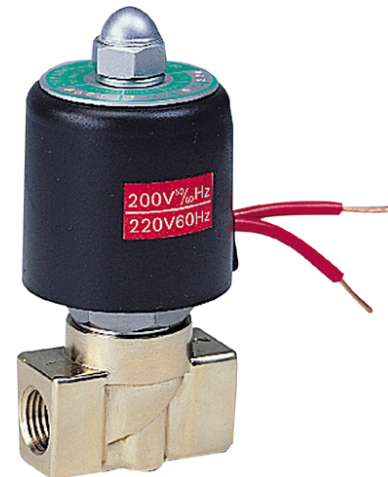

● SA-6A~10A Operation Chart

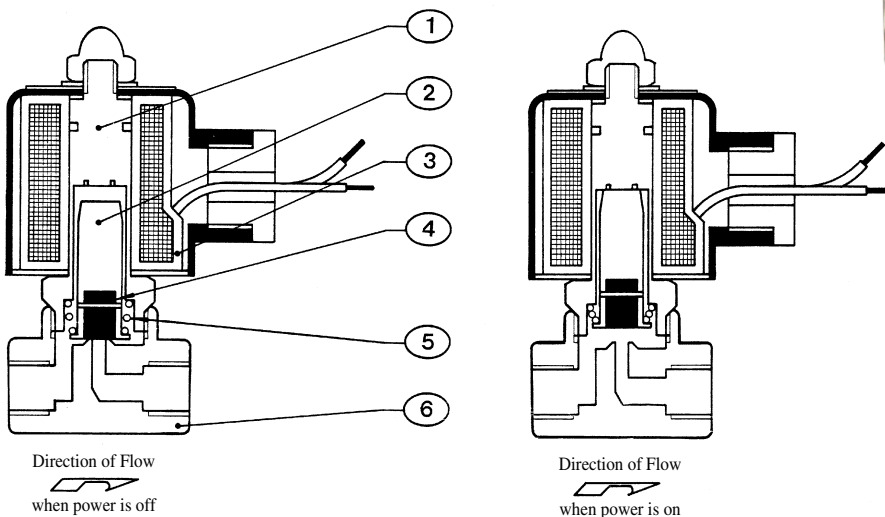

● Material Table

Item	Article	Material
1	Solenoid Tube	Stainless Steel
2	Armature Core	Stainless Steel
3	Coil	Brass Wire
4	Seat	Teflon®
5	Spring	Stainless Steel
6	Valve Body	Forged Brass



2/2-way solenoid valve of forged brass body for high temperature application

Piston Type

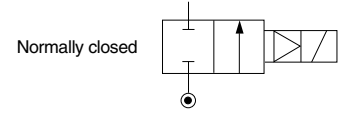

Model	Port size	Orifice (mm)	CV value	Fluid temp. (°C)	Seat disc	Differential pressure kg/cm ² (bar)				Wt. (kg)
						Liquid	Air	Steam	Oil (200°C)	
SA - 14	3/8 "	15	4.5	-10	PTFE	0.5-20	0.5-20	0.5-12	0.5-20	1.15
SA - 15	1/2 "	15	4.5			0.5-20	0.5-20	0.5-12	0.5-20	1.13
SA - 20	3/4 "	20	9.3			0.5-20	0.5-20	0.5-12	0.5-20	1.53
SA - 25	1 "	25	13.2			0.5-20	0.5-20	0.5-12	0.5-20	1.85
SA - 35	1 1/4 "	35	26			0.5-20	0.5-20	0.5-12	0.5-20	3.35
SA - 40	1 1/2 "	35	26			0.5-20	0.5-20	0.5-12	0.5-20	3.30
SA - 50	2 "	50	48			0.5-20	0.5-20	0.5-12	0.5-20	6.85
SA - 25AF	1 " Flange	25	13.2	180 (200)	PTFE	0.5-20	0.5-20	0.5-12	0.5-20	4.6
SA - 35AF	1 1/4 " Flange	35	26			0.5-20	0.5-20	0.5-12	0.5-20	7.5
SA - 40AF	1 1/2 " Flange	35	26			0.5-20	0.5-20	0.5-12	0.5-20	7.65
SA - 50AF	2 " Flange	50	48			0.5-20	0.5-20	0.5-12	0.5-20	12.6

How to order

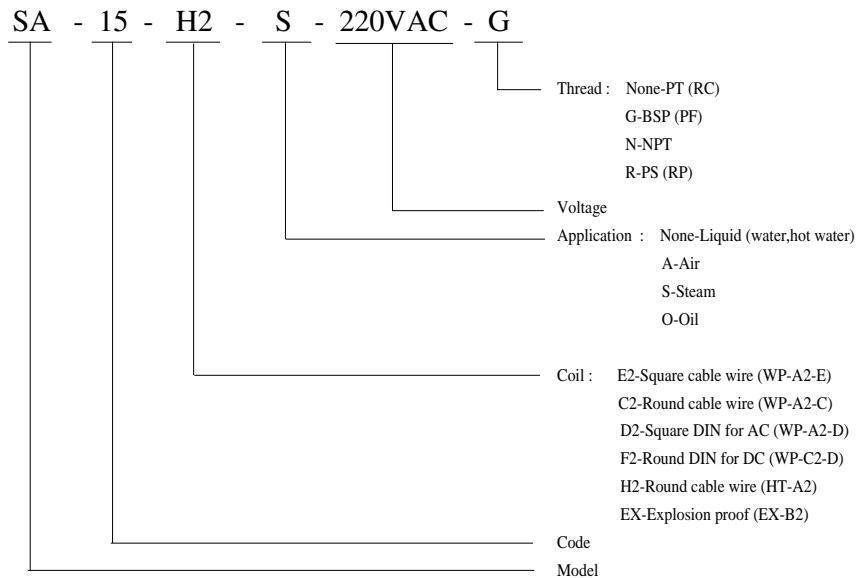

Notes:

- In order to prolong operating life, it is better to allocate pipe horizontally and coil to face upward.
- Voltage drop range is within $\pm 10\%$.
- Pressure of voltage DC is 70% of voltage AC only.
- Combined plunger seat & piston ring are made of Teflon®.
- Max. temperature is up to 200°C.
- Selection of coil refer to page 136~139.
- Pressure: 40 kg/cm² (bar) for liquid and air is custom-made.

Inapplicable Fluids:

- Fluids that have kinematic viscosity over 50 CST.
- Fluids that will turn to liquid after being heated and become solid after being cooled.
- Corrosive fluids.

SA

2/2-way solenoid valve of forged brass body for high temperature application

● SA-14~50 Contour Specification Chart

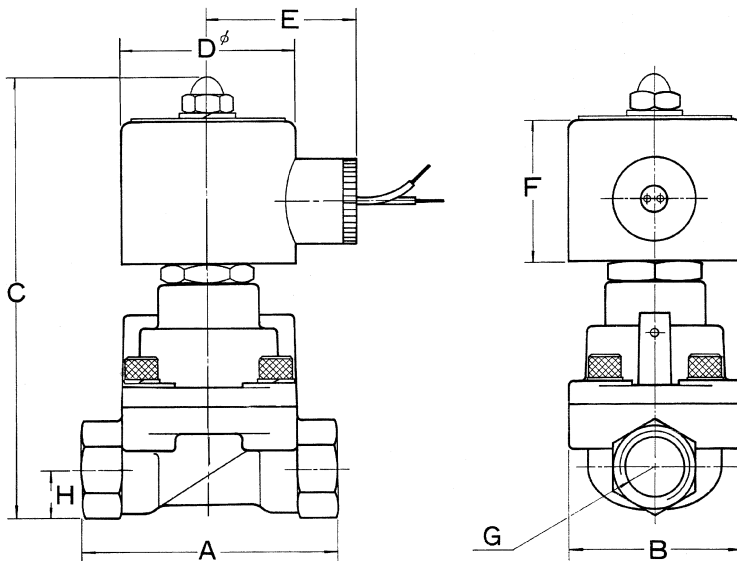

● Specifications

Unit:mm

Item Model	A	B	C	D	E	F	G	H	Coil Model
SA - 14	75	52	129	53	47	43	3/8 "	14.5	HT-A2
SA - 15	75	52	129	53	47	43	1/2 "	14.5	HT-A2
SA - 20	85	60	141	53	47	43	3/4 "	18	HT-A2
SA - 25	100	70	148	53	47	43	1"	23	HT-A2
SA - 35	120	90	168	53	47	43	1 1/4"	33	HT-A2
SA - 40	120	90	168	53	47	43	1 1/2"	33	HT-A2
SA - 50	150	120	203	53	47	43	2 "	40.5	HT-A2



● SA-14~50 Operation Chart

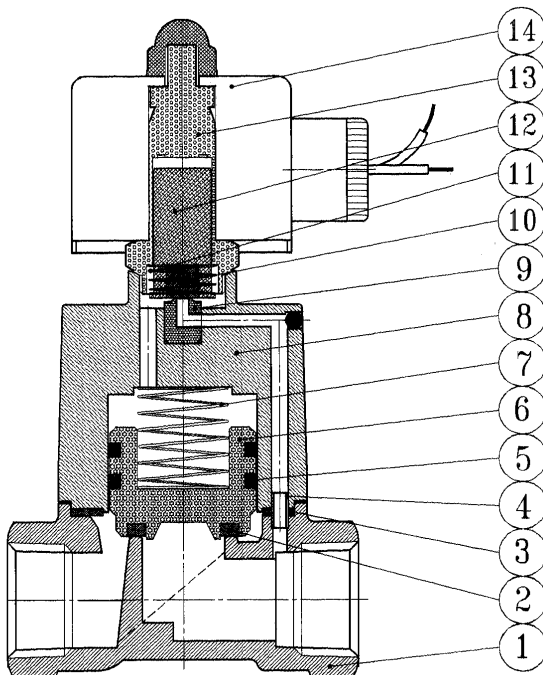

● Material Table

Item	Article	Material
1	Valve Body	Forged Brass
2	Piston Seat	Teflon®
3	Leakproof Gasket	Teflon®
4	Fixed Pin	Stainless Steel
5	Piston Ring	MoS ₂ +Teflon®
6	Piston	Brass
7	Spring	Stainless Steel
8	Valve Bonnet	Forged Brass
9	Sleeve	Stainless Steel
10	Seat	Teflon®
11	Spring	SUS 304
12	Armature Core	Stainless Steel
13	Solenoid Tube	Stainless Steel
14	Coil	Brass Wire

SA

2/2-way solenoid valve of forged brass body for high temperature application

● SA-25AF~50AF Contour Specification Chart

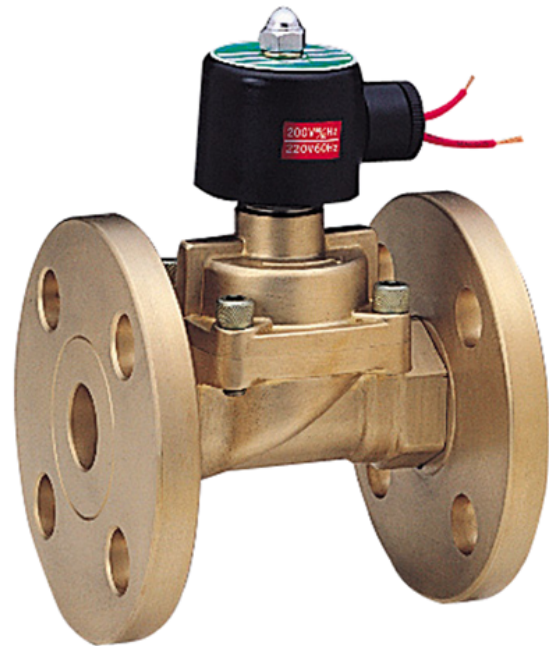
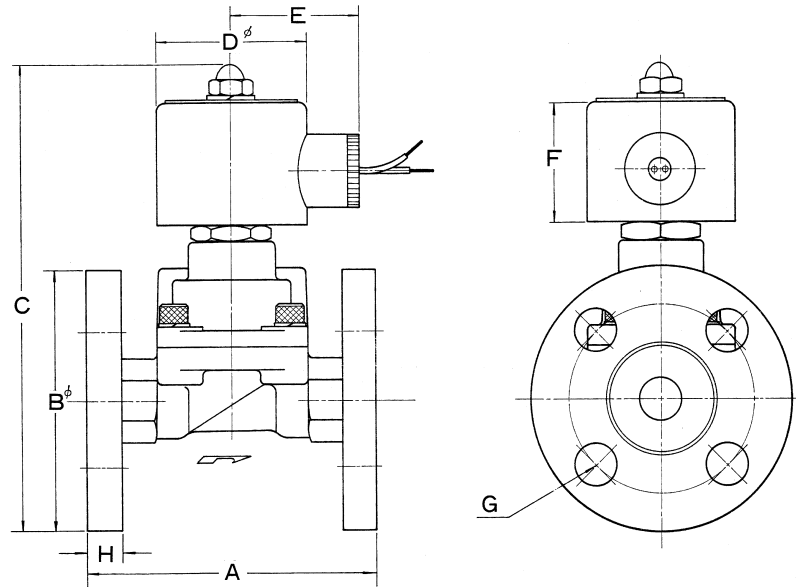

● Specifications

Unit : mm

Item / Model	A	B	C	D	E	F	G	G Hole No.	H
SA-25AF	130	125	188	53	47	43	19	4	14
SA-35AF	160	135	202	53	47	43	19	4	16
SA-40AF	160	140	205	53	47	43	19	4	16
SA-50AF	200	155	240	53	47	43	19	4	16

JIS Flange Specification:10kg/cm²



2/2-way solenoid valve of forged brass body for high temperature application

Flow Curve Chart

● Fluid: Steam SA-14.15

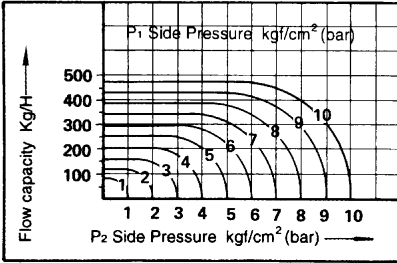

● Fluid: Steam SA-20

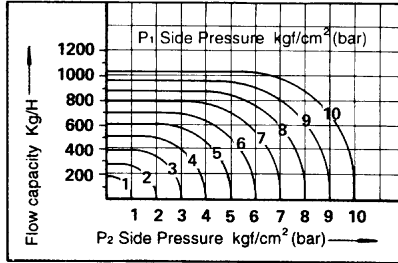

● Fluid: Steam SA-25(AF)

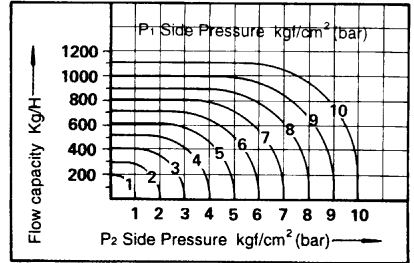

● Fluid: Steam SA-35.40(AF)

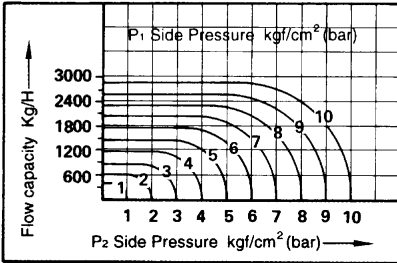

● Fluid: Air SA-14.15

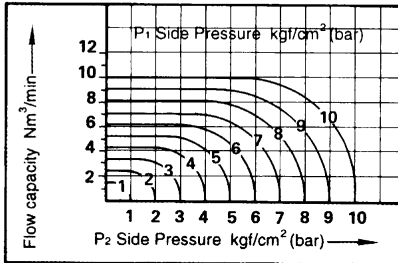

● Fluid: Air SA-20

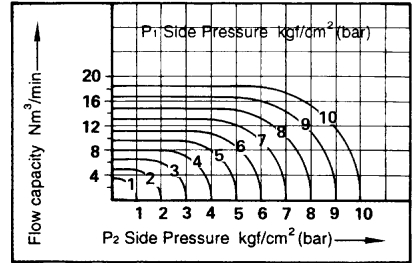

● Fluid: Air SA-25(AF)

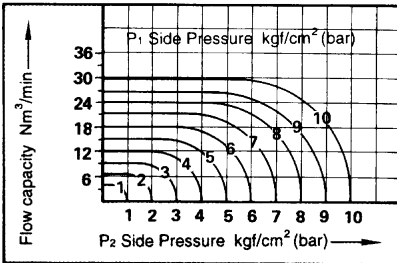

● Fluid: Air SA-35.40(AF)

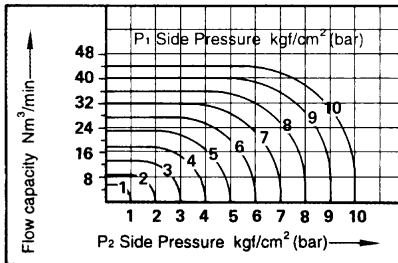

● Fluid: Liquid SA-14-50(AF)

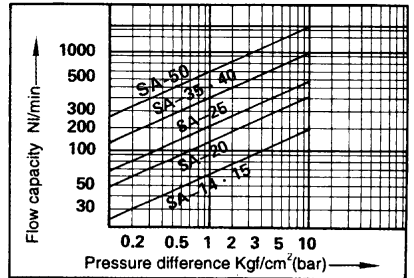

● Fluid: Steam SA-50(AF)

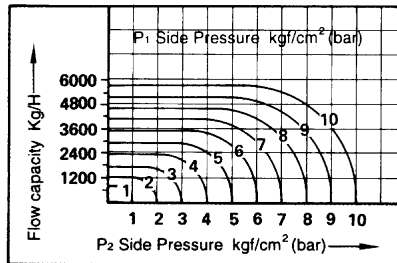

● Fluid: Air SA-50(AF)

